

General Description

The AAT2847 is a highly integrated power solution for single cell Li-Ion/Polymer based liquid crystal display (LCD) display applications. It includes a four channel light emitting diode (LED) backlight driver and two integrated 200mA low dropout voltage regulators (LDOs) as additional power supplies for display and camera related chipsets.

The backlight driver in the AAT2847 is a low noise tri-mode DC/DC charge pump converter. Each of the four channels of the backlight driver is capable of delivering up to 20mA of bias currents for white LEDs. The white LED (WLED) backlight bias current matching is 1% which helps provide uniform display brightness.

AnalogicTech's AS²Cwire™ (Advanced Simple Serial Control™) serial digital interface is used to enable, disable, and set the current for each backlight LED channel. Each LED channel has sixteen available current level settings in three separate current scales, plus four available current level settings on a low level current scale.

Each LED channel is equipped with built-in short circuit protection and auto disable functionality. A low shutdown current feature disconnects the load from the input and reduces quiescent current to less than 1µA.

The AAT2847 is available in the thermally enhanced 20-pin 3x4x0.75mm TQFN package.

Typical Application

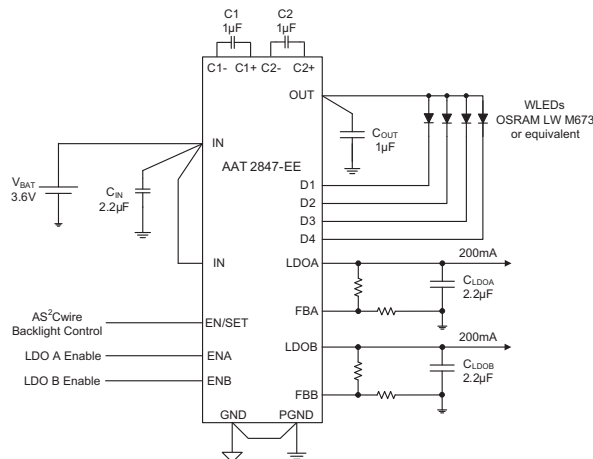

Features

- Input Supply Voltage Range: 2.7V to 5.5V
- Tri-Mode (1X/1.5X/2X) Charge Pump:
 - Delivers up to 120mA of Output Current
- Integrated LCD Display Solution:
 - Four-Channel WLED Backlight
 - User-Programmable WLED Current Scales: 30mA, 20mA and 15mA.
 - Sixteen Programmable Current Level Settings
 - User Selectable Low Level Current Scale
 - Four Programmable Current Level Settings
 - Dual 200mA LDOs (w/Separate Enables)
- Single-Wire AS²Cwire Serial Interface for Configuration/Control
 - Four Addressable Registers
 - Fast, 1MHz Serial Interface
- > 90% Peak Efficiency
- LDO Output Voltages:
 - AAT2847-EE: User-Programmable
 - AAT2847-QG: 2.8V and 1.5V
 - AAT2847-QI: 2.8V and 1.8V
- Over-Temperature Protection
- Available in 3x4x0.75mm TQFN34-20 Package
- -40°C to +85°C Temperature Range

Applications

- Camera Function Power Supplies
- Camera Phone Displays
- LCD Modules
- White LED Backlighting

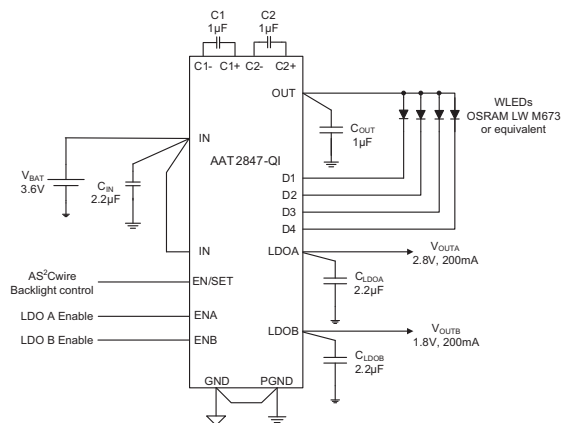

Pin Descriptions

Pin #	Symbol		Function
	AAT2847-EE	AAT2847-QG/QI	
1	D2	D2	LED2 current channel input. Connect to the cathode of backlight LED 2. If not used, connect D2 to the OUT pin.
2	D1	D1	LED1 current channel input. Connect to the cathode of backlight LED 1. If not used, connect D1 to the OUT pin.
3	LDOB	LDOB	Output of LDOB.
4, 6	IN	IN	Input voltage supply connection.
5	PGND	PGND	Power Ground.
7	FBA	NC	AAT2847-EE: Feedback pin of LDOA. Internally regulated at 1.2V. AAT2847-QG/QI: No connection. Do not make any connection to this pin.
8	LDOA	LDOA	Output of LDOA.
9	C2-	C2-	Negative terminal of flying capacitor 2.
10	C2+	C2+	Positive terminal of flying capacitor 2.
11	OUT	OUT	Charge pump output to drive load circuit. Connect a 1 μ F or larger ceramic capacitor between OUT and PGND.
12	C1-	C1-	Negative terminal of flying capacitor 1.
13	C1+	C1+	Positive terminal of flying capacitor 1.
14	EN/SET	EN/SET	AS ² Cwire control pin for backlight LED current profile selection and control.
15	ENB	ENB	Enable pin for LDOB. Active logic high.
16	D4	D4	LED4 current channel input. Connect to the cathode of backlight LED 4. If not used, connect D4 to the OUT pin.
17	D3	D3	LED3 current channel input. Connect to the cathode of backlight LED 3. If not used, connect D3 to the OUT pin.
18	GND	GND	Ground.
19	ENA	ENA	Enable pin for LDOA. Active logic high.
20	FBB	N/C	AAT2847-EE: Feedback pin of LDOB. Internally regulated at 1.2V. AAT2847-QG/QI: No connection. Do not make any connection to this pin.
EP			Exposed pad (bottom).

Pin Configuration

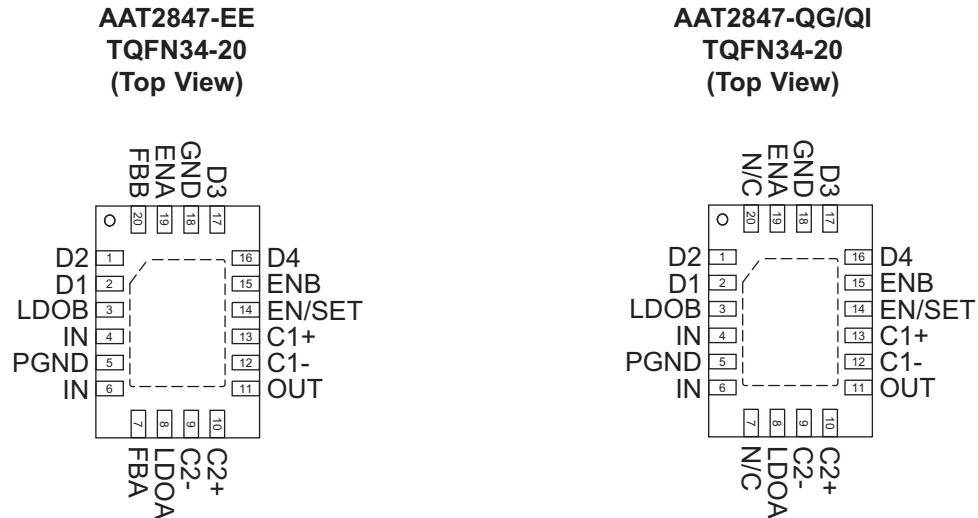

Absolute Maximum Ratings¹

$T_A = 25^\circ\text{C}$, unless otherwise noted. Pin descriptions below apply to AAT2847-EE (AAT2847-QG/QI)

Symbol	Description	Value	Units
V_N	[IN, OUT, D1, D2, D3, D4] to GND	-0.3 to 6.0	V
V_N	[C1+, C1-, C2+, C2-] to GND	-0.3 to $V_{OUT} + 0.3$	V
V_N	[LDOA, LDOB, FBA, FBB, EN/SET, ENA, ENB] to GND	-0.3 to $V_{IN} + 0.3$	V
T_J	Operating Temperature Range	-40 to 150	$^\circ\text{C}$
T_{LEAD}	Maximum Soldering Temperature (at leads, 10 sec)	300	$^\circ\text{C}$

Thermal Information^{2, 3}

Symbol	Description	Value	Units
θ_{JA}	Thermal Resistance	50	$^\circ\text{C}/\text{W}$
P_D	Maximum Power Dissipation	2	W

1. Stresses above those listed in Absolute Maximum Ratings may cause permanent damage to the device. Functional operation at conditions other than the operating conditions specified is not implied. Only one Absolute Maximum Rating should be applied at any one time.
2. Derate 20mW/ $^\circ\text{C}$ above 40 $^\circ\text{C}$ ambient temperature.
3. Mounted on a FR4 circuit board.

Electrical Characteristics¹

$V_{IN} = 3.6V$; $C_{IN} = C_{LDOA} = C_{LDOB} = 2.2\mu F$; $C_{OUT} = 1\mu F$; $C1 = C2 = 1\mu F$; $T_A = 25^\circ C$, unless otherwise noted. Typical values are at $T_A = 25^\circ C$.

Symbol	Description	Conditions	Min	Typ	Max	Units
Power Supply						
V_{IN}	Input Voltage Range		2.7		5.5	V
I_{SHDN}	Total Shutdown Current at IN	$V_{EN/SET} = V_{ENA} = V_{ENB} = 0V$			1.0	μA
Charge Pump						
I_{IN}	Input Operating Current	1x Mode, $3.0 \leq V_{IN} \leq 5.5$, Active, No Load, $V_{ENA} = V_{ENB} = 0V$			1.0	mA
		1.5x Mode, $3.0 \leq V_{IN} \leq 5.5$, Active, No Load, $V_{ENA} = V_{ENB} = 0V$			4.0	
		2x Mode, $3.0 \leq V_{IN} \leq 5.5$, Active, No Load, $V_{ENA} = V_{ENB} = 0V$			5.0	
I_{DX}	Average Current Accuracy	DATA 1, 20mA Range	18	20	22	mA
		DATA 2, ADDRESS 4	0.9	1.0	1.1	
		DATA 1, 30mA Range		30		
		DATA 1, 15mA Range		15		
$I_{(D-Match)}$	Current Matching ²	$V_{IN} - V_F = 1.5V$, 20mA Range		0.5	1	%
V_{TH}	1x to 1.5x or 1.5x to 2x Transition Threshold at Any DX Pin	20mA Range		150		mV
f_{CLK}	Clock Frequency			1		MHz
T_{SD}	Over-Temperature Shutdown Threshold			140		$^\circ C$
T_{HYS}	Over-Temperature Shutdown Hysteresis			15		$^\circ C$
EN/SET Logic Control						
$T_{EN/SET LO}$	EN/SET Low Time		0.3		75	μs
$T_{EN/SET HI_MIN}$	Minimum EN/SET High Time			50		ns
$T_{EN/SET HI_MAX}$	Maximum EN/SET High Time				75	μs
T_{OFF}	EN/SET Off Timeout				500	μs
T_{LAT}	EN/SET Latch Timeout				500	μs
$V_{IL(EN/SET)}$	EN/SET Logic Low Threshold Voltage				0.4	V
$V_{IH(EN/SET)}$	EN/SET Logic High Threshold Voltage		1.4			V
$I_{EN/SET}$	EN/SET Input Leakage	$V_{EN/SET} = V_{IN} = 5V$	-1		1	μA

- The AAT2847 is guaranteed to meet performance specifications over the $-40^\circ C$ to $+85^\circ C$ operating temperature range is assured by design, characterization and correlation with statistical process controls.
- Current matching is defined as the deviation of any sink current from the average of all active channels.

Electrical Characteristics¹

$V_{IN} = 3.6V$; $C_{IN} = C_{LDOA} = C_{LDOB} = 2.2\mu F$; $C_{OUT} = 1\mu F$; $C1 = C2 = 1\mu F$; $T_A = 25^\circ C$, unless otherwise noted. Typical values are at $T_A = 25^\circ C$.

Symbol	Description	Conditions	Min	Typ	Max	Units
LDOs: AAT2847-EE						
I_{IN}	IN Operating Current	$V_{ENA} = V_{ENB} = V_{IN}$, $V_{EN/SET} = 0V$, No Load		80	150	μA
		$V_{ENA} = V_{IN}$; $V_{ENB} = 0V$; $V_{EN/SET} = 0V$; No Load		60	112	
V_{FBA} , V_{FBB}	Feedback Voltage	$I_{LDO[A/B]} = 1mA$ to 200mA	1.17	1.2	1.23	V
V_{DO}	Dropout Voltage	$I_{LDO[A/B]} = 150mA$		150	300	mV
$\frac{\Delta V_{OUT}}{V_{OUT}} \div \Delta V_{IN}$	Line Regulation	$V_{IN} = (V_{LDO[A/B]} + 1V)$ to 5V		0.09		%/V
PSRR	Power Supply Rejection Ratio	$I_{LDO[A/B]} = 10mA$, 1kHz		50		dB
LDOs: AAT2847-QG						
I_{IN}	IN Operating Current	$V_{ENA} = V_{ENB} = V_{IN}$, $V_{EN/SET} = 0V$, No Load		80	150	μA
		$V_{ENA} = V_{IN}$; $V_{ENB} = 0V$; $V_{EN/SET} = 0V$; No Load		60	112	
LDOA	LDOA Voltage Tolerance	$I_{LDOA} = 1mA$ to 150mA	2.716	2.8	2.884	V
LDOB	LDOB Voltage Tolerance	$I_{LDOB} = 1mA$ to 150mA	1.455	1.5	1.545	V
V_{DO}	LDOA Dropout Voltage ²	$I_{LDOA} = 150mA$		150	300	mV
$\frac{\Delta V_{LDO[A/B]}}{V_{LDO[A/B]}} \div \Delta V_{IN}$	LDOA, LDOB Line Regulation	$V_{IN} = (LDOA + 1V)$ to 5V; $V_{IN} = (LDOB + 1.2V)$ to 5V		0.09		%/V
PSRR	LDOA, LDOB Power Supply Rejection Ratio	$I_{LDO[A/B]} = 10mA$, 1kHz		50		dB
LDOs: AAT2847-QI						
I_{IN}	IN Operating Current	$V_{ENA} = V_{ENB} = V_{IN}$, $V_{EN/SET} = 0V$, No Load		80	150	μA
		$V_{ENA} = V_{IN}$; $V_{ENB} = 0V$; $V_{EN/SET} = 0V$; No Load		60	112	
LDOA	LDOA Voltage Tolerance	$I_{LDOA} = 1mA$ to 150mA	2.716	2.8	2.884	V
LDOB	LDOB Voltage Tolerance	$I_{LDOB} = 1mA$ to 150mA	1.746	1.8	1.854	V
V_{DO}	LDOA Dropout Voltage ²	$I_{LDOA} = 150mA$		150	300	mV
$\frac{\Delta V_{LDO[A/B]}}{V_{LDO[A/B]}} \div \Delta V_{IN}$	LDOA, LDOB Line Regulation	$V_{IN} = (LDO[A/B] + 1V)$ to 5V		0.09		%/V
PSRR	LDOA, LDOB Power Supply Rejection Ratio	$I_{LDO[A/B]} = 10mA$, 1kHz		50		dB
LDO Logic Control – All Options						
$V_{IL(ENA)}$, $V_{IL(ENB)}$	ENA, ENB Input Logic Low Threshold Voltage				0.4	V
$V_{IH(ENA)}$, $V_{IH(ENB)}$	ENA, ENB Input Logic High Threshold Voltage		1.4			V
$I_{EN[A/B]}$	ENA, ENB Input Leakage	$V_{EN[A/B]} = V_{IN} = 5V$	-1		1	μA

- The AAT2847 is guaranteed to meet performance specifications over the $-40^\circ C$ to $+85^\circ C$ operating temperature range is assured by design, characterization and correlation with statistical process controls.
- V_{DO} is defined as $V_{IN} - LDOA$ when LDOA is 98% of nominal.

Typical Characteristics

Backlight Efficiency vs. Input Voltage

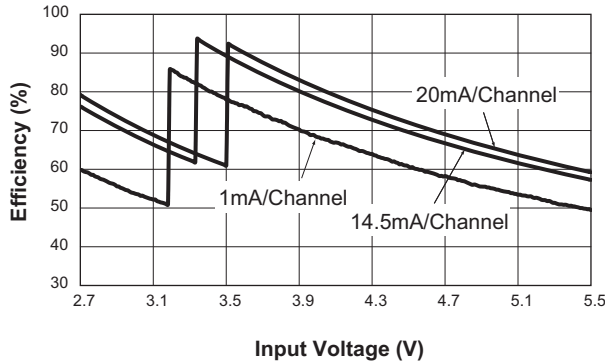

Backlight Current Matching vs. Temperature
($I_{OUT} = 20\text{mA/Channel}$; $V_{IN} = 4.2\text{V}$)

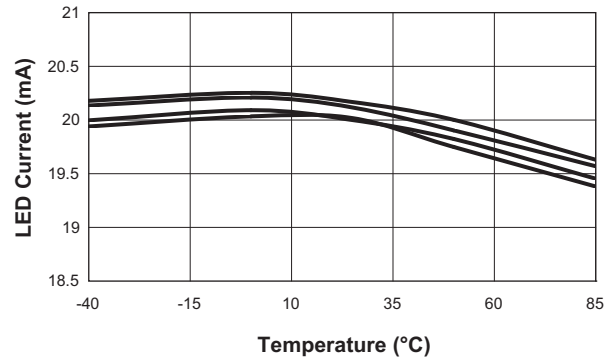

EN/SET Latch Timeout vs. Input Voltage

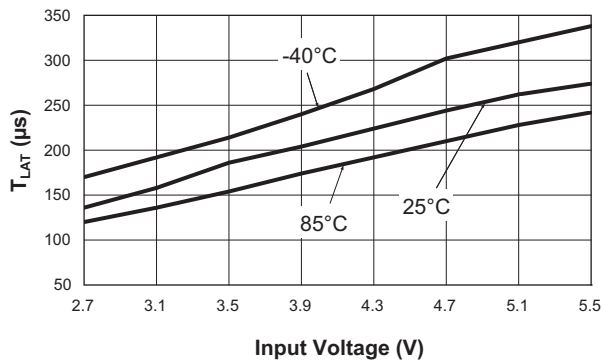

EN/SET Off Timeout vs. Input Voltage

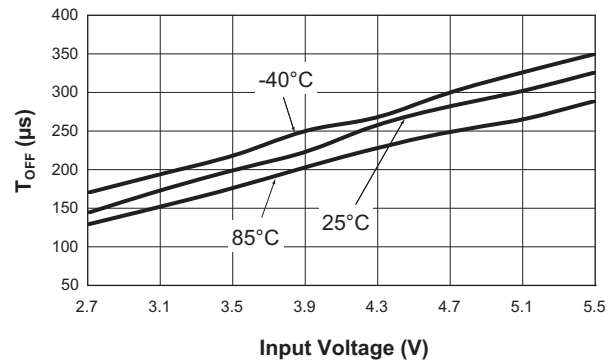

Logic High Threshold Voltage vs. Input Voltage

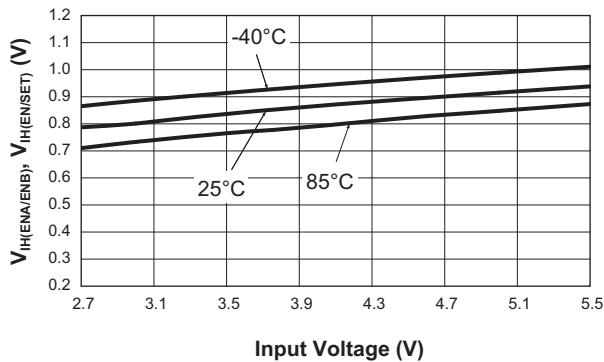

Logic Low Threshold Voltage vs. Input Voltage

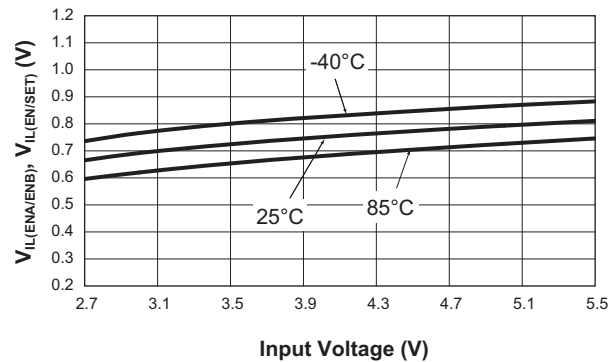

Typical Characteristics

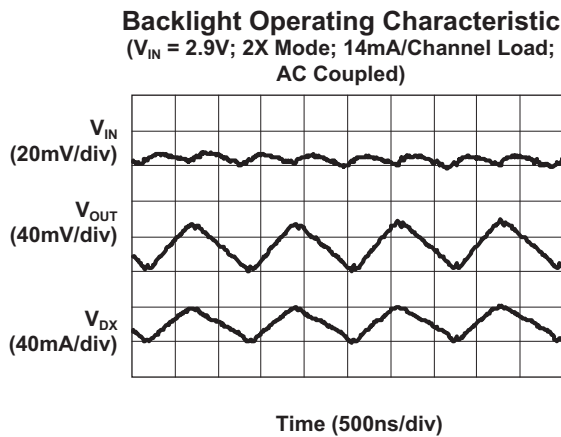
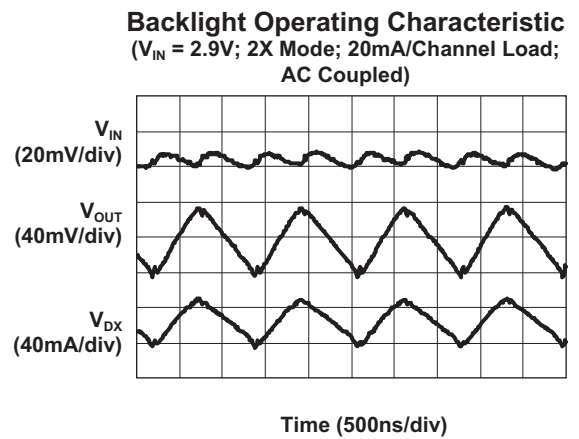
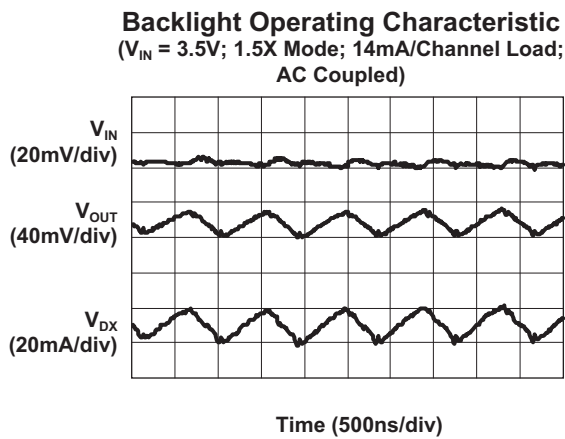
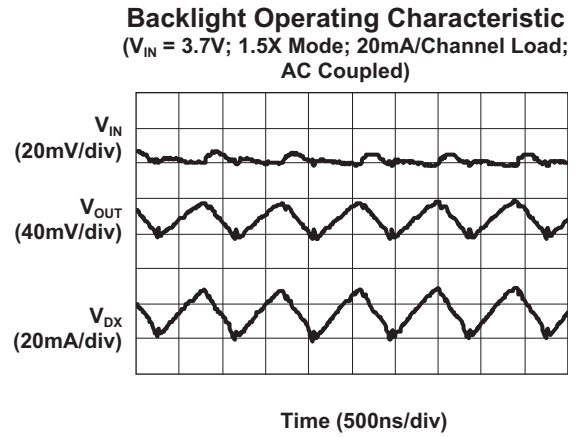
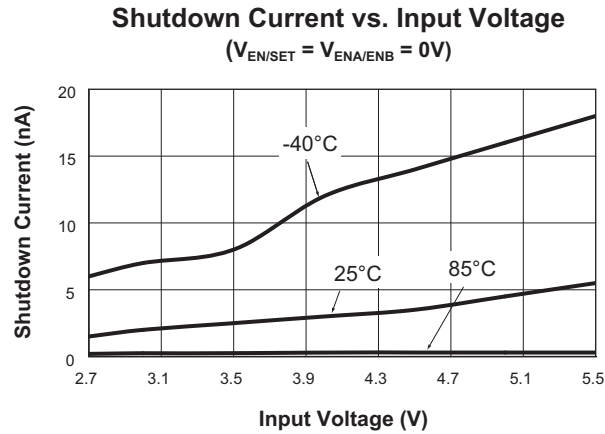

Typical Characteristics

Turn On to 1X Mode Backlight
(20mA/Channel; Address 0, Data 1; $V_{IN} = 4.2V$)

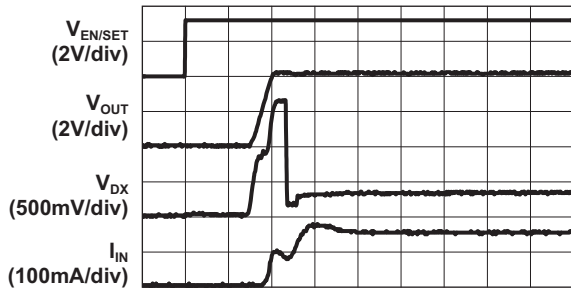

Time (500ns/div)

Turn On to 1.5X Mode Backlight
(20mA/Channel; Address 0, Data 1; $V_{IN} = 3.5V$)

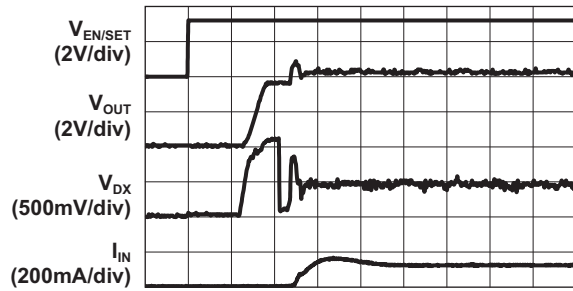

Time (200µs/div)

Turn On to 2X Mode Backlight
(20mA/Channel; Address 0, Data 1; $V_{IN} = 3.2V$)

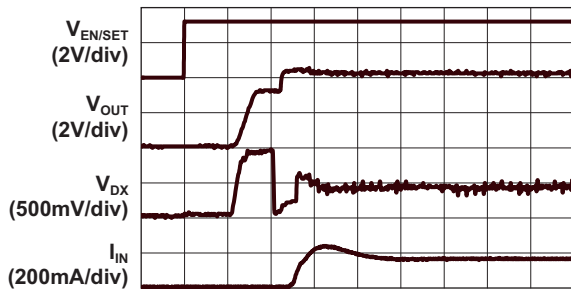

Time (200µs/div)

Turn Off from 1.5X Mode Backlight
(20mA/Channel; Address 0, Data 1; $V_{IN} = 3.6V$)

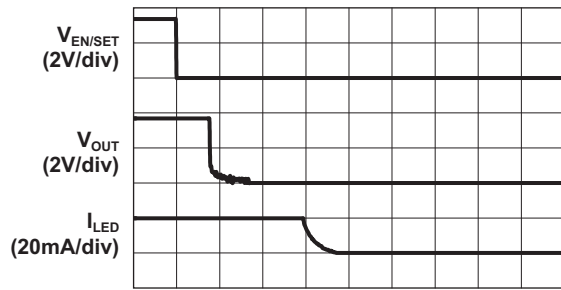

Time (100µs/div)

LDOA/LDOB Load Regulation

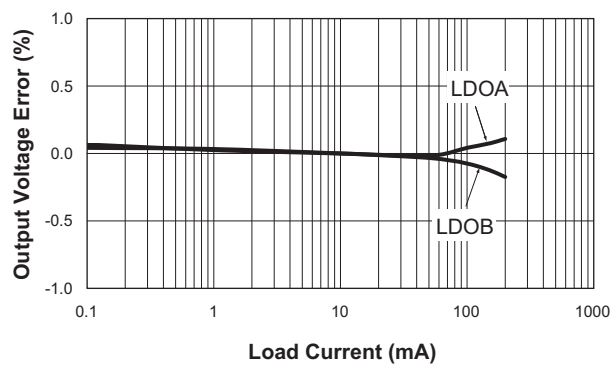

LDOA/LDOB Line Regulation

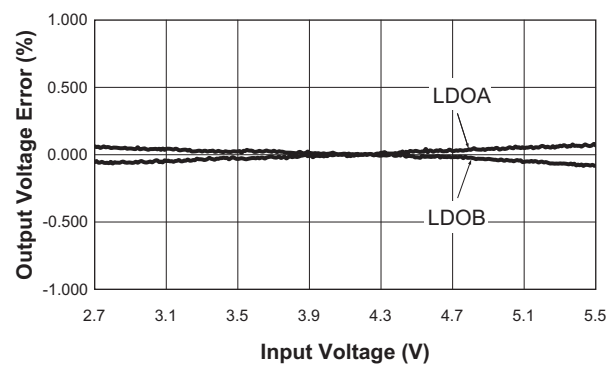

Typical Characteristics

LDOA/LDOB Quiescent Current vs. Input Voltage
($V_{OUT} = 1.2V$)

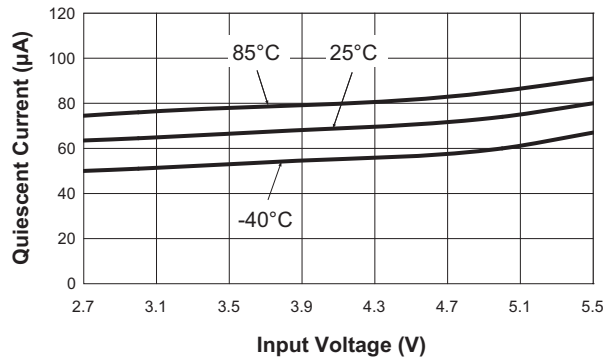

LDOA Load Transient Response
($V_{IN} = 3.6V$; $V_{LDOA} = 1.2V$)

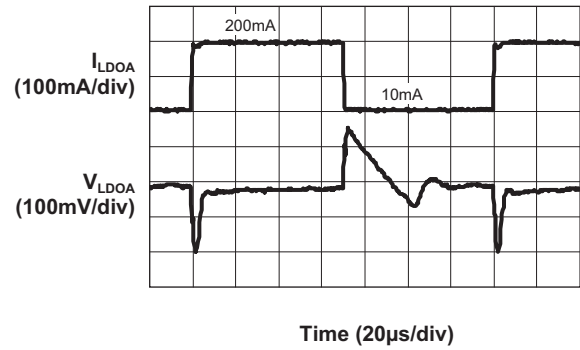

LDOB Load Transient Response
($V_{IN} = 3.6V$; $V_{LDOB} = 1.2V$)

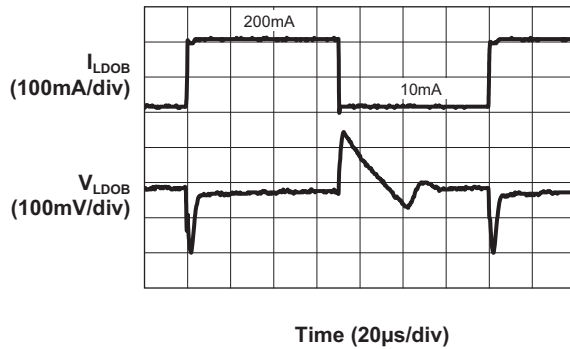

LDOA Line Transient Response (10mA Load)

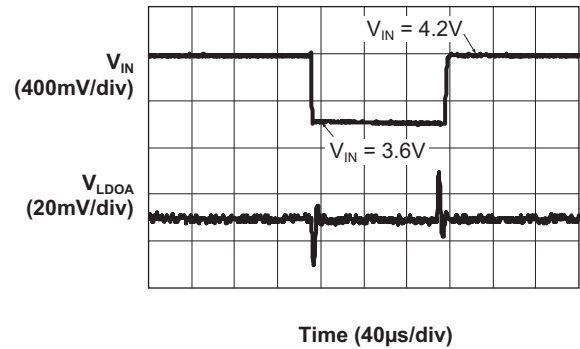

LDOB Line Transient Response (10mA Load)

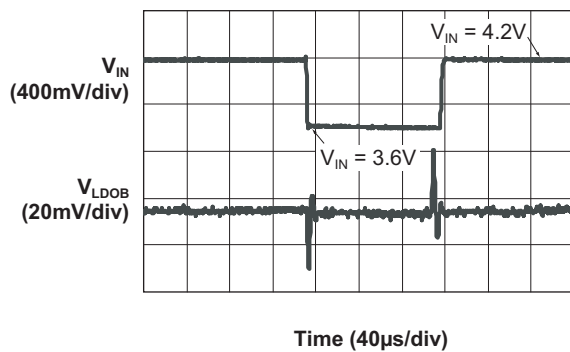

Typical Characteristics

LDOA/LDOB Turn On
($V_{IN} = 3.6V$; $V_{LDO(A/B)} = 2.8V$; DC Coupled)

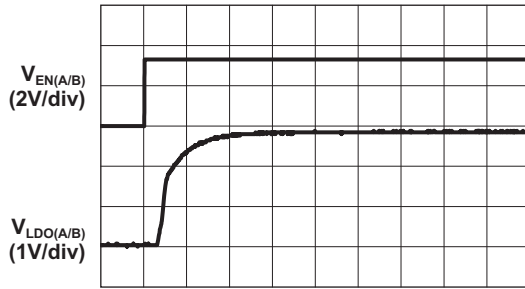

Time (40µs/div)

LDOA/LDOB Turn On
($V_{IN} = 3.6V$; $V_{LDO(A/B)} = 1.8V$; DC Coupled)

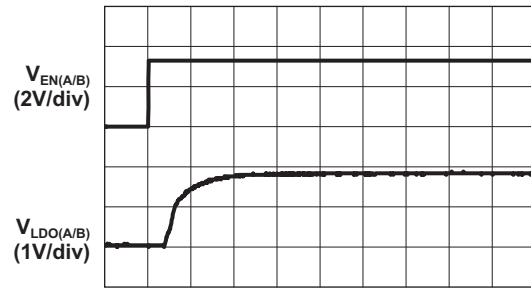

Time (40µs/div)

LDOA/LDOB Turn On
($V_{IN} = 3.6V$; $V_{LDO(A/B)} = 1.5V$; DC Coupled)

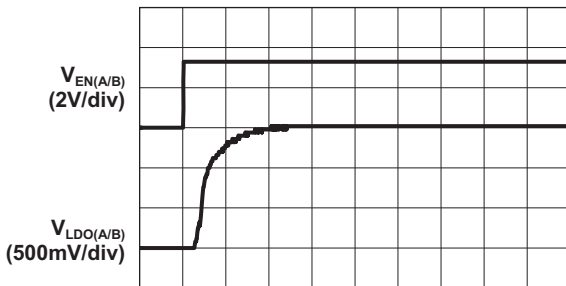

Time (40µs/div)

LDOA/LDOB Turn On
($V_{IN} = 3.6V$; $V_{LDO(A/B)} = 1.2V$; DC Coupled)

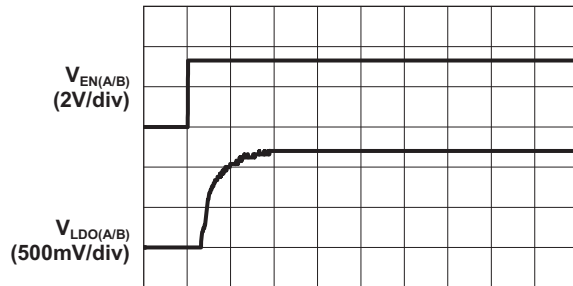

Time (40µs/div)

Functional Block Diagram

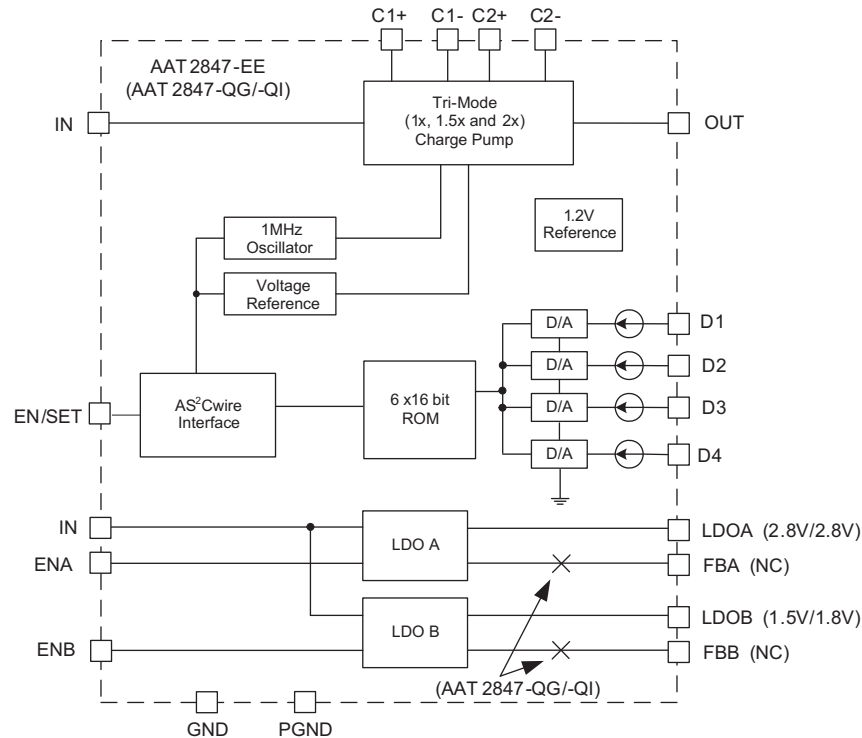

Functional Description

The AAT2847 is an integrated solution for LCD display applications with a built-in four channel white LED driver (charge pump) and dual 200mA LDO voltage regulators. The AAT2847 incorporates a tri-mode charge pump with load switch (1X) functionality and high efficiency (1.5X or 2X) performance. To maximize power conversion efficiency, an internal sensing circuit monitors the voltage required at each white LED cathode input pin (D1-D4) and sets the load switch and charge pump mode based on the input battery voltage and the white LED cathode pin voltage. The voltage threshold for 1X to 1.5X and 1.5X to 2X mode transitions is V_{TH} .

The charge pump in the AAT2847 starts-up in 1X mode (default); under this condition, if the LED cathode input pin voltage is below V_{TH} the AAT2847 will transition into 1.5X mode. When 1.5X mode does not provide enough current through the white LEDs for backlight applications, which occurs during the normal discharge of the

input battery power source, the LED cathode input pin voltage will drop below V_{TH} and the AAT2847 will transition into 2X mode. The charge pump requires only four external capacitors, 1 μ F ceramic capacitors for the flying (C1 and C2), input (C_{IN}), and output (C_{OUT}) capacitors.

The four LED cathode input pins (D1-D4) can drive individual LEDs with a maximum current of 30mA each. The unused LED cathode input pins have to be connected to the OUT pin, otherwise the AAT2847 will operate in 2X mode only. Operating in 2X mode when it is not necessary will result in a significant reduction in efficiency. The AS²Cwire serial interface enables the charge pump and sets the current flowing into the LED cathode input pins.

The AAT2847 also contains dual LDO voltage regulators that have separate enable pins from each other and the charge pump. The separate enable pins for each DC/DC device in the AAT2847 allow for every possible device operational combination. The two LDO regulators require 2.2 μ F output capacitors for stable operation.

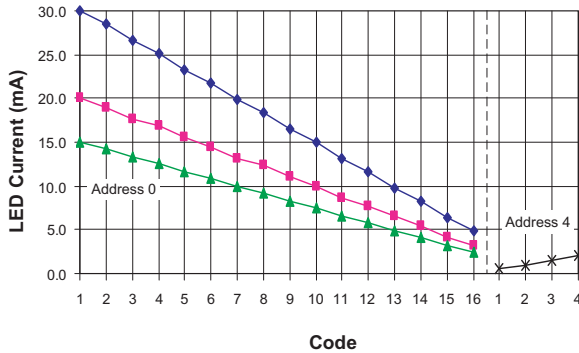

Figure 1: LED Current Control Profile.

AS²Cwire Serial Interface

Each white LED channel input on the AAT2847 (D1-D4) is controlled by AnalogicTech's AS²Cwire serial digital interface. The AS²Cwire interface uses the number of rising edges on the EN/SET pin to address and load the LED configuration registers. AS²Cwire latches data or addresses after the EN/SET pin has been held logic high for longer than T_{LAT} (500 μ s). Addresses and data are differentiated by the number of EN/SET rising edges. Since the data registers are 4 bits each, the differentiating number of pulses is 2^4 or 16, so that Address 0 is signified by 17 rising edges, Address 1 by 18 rising edges, Address 2 by 19 rising edges, and so on. Data is set to any number of rising edges between, and including, 1 to 16.

A typical write protocol consist of the following: First a burst of EN/SET rising edges that

identify/target a particular address followed by EN/SET being held logic high for the T_{LAT} timeout period to latch the address value in the address register, then another burst of rising edges that signify data with the accompanying T_{LAT} timeout period to latch the data value in the data register. Once an address is set, then multiple writes to the corresponding data register are allowed without having to write to the address for every value change in the data register. When EN/SET is held low longer than T_{OFF} (500 μ s), the AAT2847 enters shutdown mode operation and draws less than 1 μ A from the input supply voltage. Data and address registers are cleared (0 for the address register and 1 for the data registers) in shutdown mode operation.

AS²Cwire Serial Interface Addressing

Address	EN/SET Edges	Addressed Register
0	17	D1-D4 Current Control
3	20	Current Scale
4	21	Low Current Control
5	22	Independent LED Control

Table 1: AS²Cwire Serial Interface Addressing.

Current Operation (Address 0)

Use Address 0 to program all four LED channels with the current values in Table 2. All four white LED channels are programmed to the same current level by writing to Address 0 followed by any Data between, and including, 1 to 16.

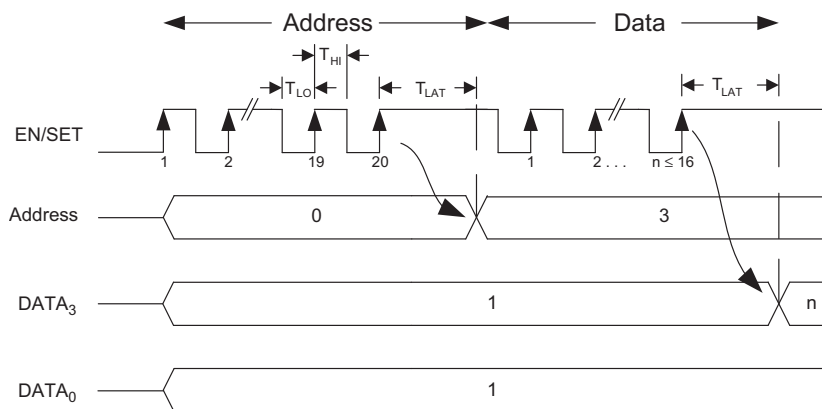

Figure 2: AS²Cwire Serial Interface Timing.

Current Scale (Address 3)

The AAT2847 has three selectable current scales for the four white LED channels: 30mA, 20mA, and 15mA. Only one of the three current scales can be active at any given time. By default, the 20mA current scale is active upon start-up. To change to the 30mA or 15mA current scale, or go back to the 20mA scale, write to Address 3 with the appropriate Data between, and including, 1 to 3. To enable low current mode, write Data 4 to Address 3. Low current mode results in the four white LED channels reverting to the current set by the low current settings in Address 4.

Data	30mA Scale	20mA Scale	15mA Scale
1	30.0	20.0	15.0
2	28.5	19.0	14.3
3	26.6	17.7	13.3
4	25.2	16.8	12.6
5	23.3	15.5	11.6
6	21.8	14.5	10.9
7	19.8	13.2	9.9
8	18.5	12.3	9.2
9	16.5	11.0	8.3
10	15.0	10.0	7.5
11	13.1	8.7	6.5
12	11.6	7.7	5.8
13	9.8	6.5	4.9
14	8.3	5.5	4.1
15	6.3	4.2	3.2
16	4.8	3.2	2.4

Table 2: Current Settings—Address 0.

Data	Current Scale
1	20mA Scale
2	30mA Scale
3	15mA Scale
4	Low Current Mode

Table 3: Current Scale Settings—Address 3.

Low Current Operation (Address 4)

All four LED channels are programmed to the same low current level by writing to Address 4 followed by any Data between, and including, 1 to 4. This operational mode is especially useful for low current applications where a continuous low current state is maintained for a substantial length of time.

Data	mA
1	0.5
2	1.0
3	1.5
4	2.0

Table 4: Low Current Settings—Address 4.

Independent LED Current Control (Address 5)

Independent LED control allows for individual LEDs to be enabled and disabled to form custom arrangement of active LEDs. To enable independent control write Address 5 with Data between, and including, 1 to 16.

Data	D4	D3	D2	D1
1	on	on	on	on
2	on	on	on	off
3	on	on	off	on
4	on	on	off	off
5	on	off	on	on
6	on	off	on	off
7	on	off	off	on
8	on	off	off	off
9	off	on	on	on
10	off	on	on	off
11	off	on	off	on
12	off	on	off	off
13	off	off	on	on
14	off	off	on	off
15	off	off	off	on
16	off	off	off	off

Table 5: Independent LED Control Settings—Address 5.

Auto Disable Feature

The charge pump in the AAT2847 is equipped with an auto-disable feature for each LED channel. After the IC is enabled and successively starts-up, a test current of 100 μ A (typical) is forced through each LED channel. The channel will be disabled if the voltage on that particular DX pin does not drop to certain threshold. This feature is convenient for disabling an unused channel or during an LED short circuiting event.

Low Dropout Regulators

The AAT2847 incorporates two LDO voltage regulators. The two regulators run from the same 2.7V to 5.5V input voltage as the charge pump and have separate ON/OFF control inputs, ENA and ENB. For the AAT2847-EE, the LDO output voltages are set through a resistive voltage divider from the output (LDOA or LDOB) to the feedback input (FBA or FBB). The ratio of the voltage divider resistor values determines the LDO output voltage. For the AAT2847-QG option, LDOA is internally set to 2.8V and LDOB is internally set to 1.5V. For the AAT2847-QI option, LDOA is also 2.8V and LDOB is internally set to 1.8V. Each LDO regulator can supply a continuous load current up to 200mA, and both LDOs include current limiting and thermal overload protection to prevent damage to the load or to the LDO.

Thermal Protection

The charge pump has built-in thermal protection circuitry that will shut down the charge pump and the LDOs if the die temperature rises above the thermal limit, as is the case during an OUT pin short circuit event.

Applications Information

LED Selection

The charge pump in the AAT2847 is specifically intended for driving white LEDs. However, the AAT2847 can drive most types of LEDs with forward voltage specifications ranging from 2.0V to 4.7V. LED applications may include mixed arrangements for display backlighting, color (RGB) LEDs, infrared (IR) diodes and any other load needing a constant current source generated from a varying input voltage. Since the D1 to D4 constant current channels are matched with negligible voltage dependence, the constant current channels will be matched regardless of the specific LED forward voltage (V_F) levels. Multiple channels can be combined to obtain a higher LED drive current without complication.

AAT2847-EE LDO Output Voltage Programming

The output voltages for LDOA and LDOB are programmed by an external resistor divider network. As shown in Figure 3, the selection of R1 and R2 is a straightforward matter. R1 is chosen by considering the tradeoff between the feedback network bias current and resistor value. Higher resistor values allow stray capacitance to become a larger factor in circuit performance, whereas lower resistor values decrease efficiency.

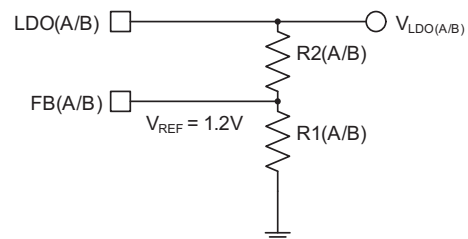

Figure 3: Selection of External Resistors.

To select appropriate resistor values, first choose a value for R1 that will produce a reasonable feedback network bias current. Then, according to the desired $V_{LDO(A/B)}$, calculate R2 according to the equation below. An example calculation follows.

R1 is chosen to be 120kΩ, resulting in a small feedback network bias current of 10μA ($V_{FB(A/B)}/R1 = 1.2V/120kΩ$). The desired output voltage is 1.8V. From this information, R2 is calculated from the equation below:

$$R2_{(A/B)} = \frac{R1_{(A/B)}(V_{LDO(A/B)} - 1.2V)}{1.2V}$$

The result is R2 = 60kΩ. Since 60kΩ is not a standard 1% resistor value, 60.4kΩ is selected. From this example calculation, for $V_{OUT} = 1.8V$, use R1 = 120kΩ and R2 = 60.4kΩ. A table of example output voltages and corresponding resistor values is provided below.

R2 Standard 1% Values (R1 = 120kΩ)	
$V_{LDO(A/B)}$ (V)	R2 (Ω)
2.8	160k
2.5	130k
2	79.6k
1.8	60.4k
1.5	30.1k

Table 6: Example Output Voltages and Corresponding Resistor Values.

Device Power Efficiency

The AAT2847's charge pump conversion efficiency is defined as the power delivered to the white LED load divided by the input power:

$$\eta = \frac{P_{LEDs}}{P_{IN}} = \frac{V_{LED1} \cdot I_{LED1} + \dots + V_{LED4} \cdot I_{LED4}}{V_{IN} \cdot I_{IN}}$$

V_{LEDx} = White LED Forward Voltage (V_F)

I_{LEDx} = White LED Bias Current (I_D)

The expression to define the estimated ideal efficiency (η) for the AAT2847 in 1X mode is as follows:

$$\eta = \frac{P_{LEDs}}{P_{IN}} = \frac{V_{LED1} \cdot I_{LED1} + \dots + V_{LED4} \cdot I_{LED4}}{V_{IN} \cdot I_{IN}}$$

$$\eta = \frac{4 \cdot V_{LEDX} \cdot I_{LEDX}}{V_{IN} \cdot I_{IN}} ; x = 1, 2, 3 \text{ or } 4 \text{ and } I_{IN} = 4 \cdot I_{LEDX}$$

$$\eta = \frac{V_{LEDX}}{V_{IN}}$$

The AAT2847's charge pump is a fractional charge pump which will boost the input supply voltage in the event where V_{IN} is less than the required output voltage across the white LED load. The efficiency can be simply defined as a linear voltage regulator with an effective white LED forward voltage that is equal to one and a half (1.5X mode) or two (2X mode) times the input voltage.

With an ideal 1.5X charge pump, the input current is 1.5X of the output current. The expression to define the estimated ideal efficiency (η) for the AAT2847 in 1.5X mode is as follows:

$$\eta = \frac{P_{LEDs}}{P_{IN}} = \frac{V_{LED1} \cdot I_{LED1} + \dots + V_{LED4} \cdot I_{LED4}}{V_{IN} \cdot I_{IN}}$$

$$\eta = \frac{4 \cdot V_{LEDX} \cdot I_{LEDX}}{V_{IN} \cdot I_{IN}} ; x = 1, 2, 3 \text{ or } 4 \text{ and } I_{IN} = 1.5(4 \cdot I_{LEDX})$$

$$\eta = \frac{V_{LEDX}}{1.5V_{IN}}$$

The same calculations apply for the AAT2847 in 2X mode where for an ideal 2X charge pump, the input current is 2X of the output current. The expression for the estimated ideal efficiency (η) for the AAT2847 in 2X mode is as follows:

$$\eta = \frac{P_{LEDs}}{P_{IN}} = \frac{V_{LED1} \cdot I_{LED1} + \dots + V_{LED4} \cdot I_{LED4}}{V_{IN} \cdot I_{IN}}$$

$$\eta = \frac{4 \cdot V_{LEDX} \cdot I_{LEDX}}{V_{IN} \cdot I_{IN}} ; x = 1, 2, 3 \text{ or } 4 \text{ and } I_{IN} = 2(4 \cdot I_{LEDX})$$

$$\eta = \frac{V_{LEDX}}{2V_{IN}}$$

Capacitor Selection

Careful selection of the six external capacitors C_{IN} , C1, C2, C_{LDOA} , C_{LDOB} , and C_{OUT} are important because they will affect turn on time, output ripple and transient performance. Optimum performance will be obtained when low ESR (<100mΩ) ceramic capacitors are used. In general, low ESR is defined as a resistance that is less than 100mΩ.

X7R and X5R type ceramic capacitors are highly recommended over all other types of capacitors for use with the AAT2847. For the charge pump section, a 1μF or greater capacitor is required for the fly (C1 and C2) and output (C_{OUT}) capacitors. The dual

LDOs require a 2.2 μ F or greater output capacitor. The required input capacitor (C_{IN}) is 2.2 μ F or greater.

Ceramic capacitors offer many advantages over their tantalum and aluminum electrolytic counterparts. A ceramic capacitor typically has very low ESR, is lowest cost, has a smaller printed circuit board (PCB) footprint, and is non-polarized. Low ESR ceramic capacitors maximize charge pump transient response.

Before choosing a particular capacitor, verify the capacitor's performance with the characteristics illustrated in the component's data sheet. Performance verification will help avoid undesirable component related performance deficiencies.

PCB Layout

To achieve adequate electrical and thermal performance, careful attention must be given to the PCB layout. In the worst-case operating condition, the chip must dissipate considerable power at full load. Adequate heat-sinking must be achieved to ensure intended operation.

Figures 5 and 6 illustrate an example PCB layout. The bottom of the package features an exposed metal pad. The exposed pad acts, thermally, to transfer heat from the chip and, electrically, as a ground connection.

The junction-to-ambient thermal resistance (θ_{JA}) for the connection can be significantly reduced by following a couple of important PCB design guidelines. The PCB area directly underneath the package should be plated so that the exposed paddle can be mated to the top layer PCB copper during the reflow process. Multiple copper plated thru-holes should be used to electrically and thermally connect the top surface pad area to additional ground plane(s).

The chip ground is internally connected to both the exposed pad and to the AGND and PGND pins. It is good practice to connect the GND pins to the exposed pad area with traces as shown in Figure 4.

The flying capacitors ($C1$ and $C2$), input capacitor ($C4$), and output capacitors ($C3$, $C5$, and $C6$) should be connected as close as possible to the IC. In addition to the external passive components being placed as close as possible to the IC, all traces connecting the AAT2847 should be as short and wide as possible to minimize path resistance and potential coupling.

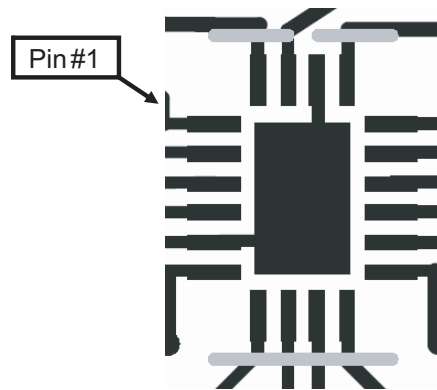

Figure 4: AAT2847 Package Layout.

Evaluation Board Layout

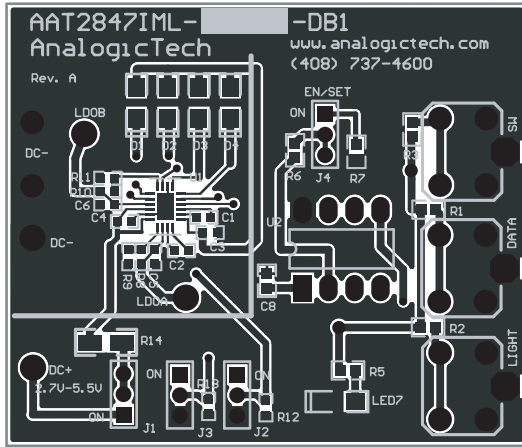

Figure 5: AAT2847 Evaluation Board Component Side Layout.

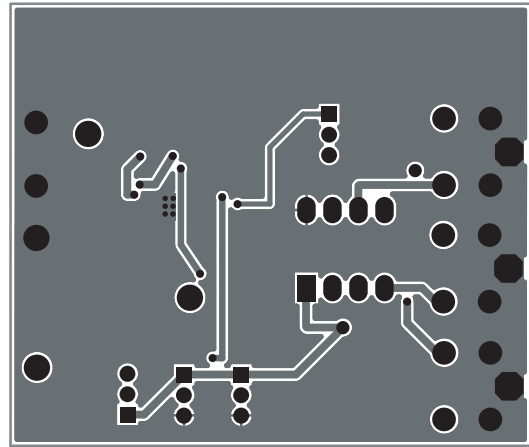

Figure 6: AAT2847 Evaluation Board Solder Side Layout.

Evaluation Board Schematic

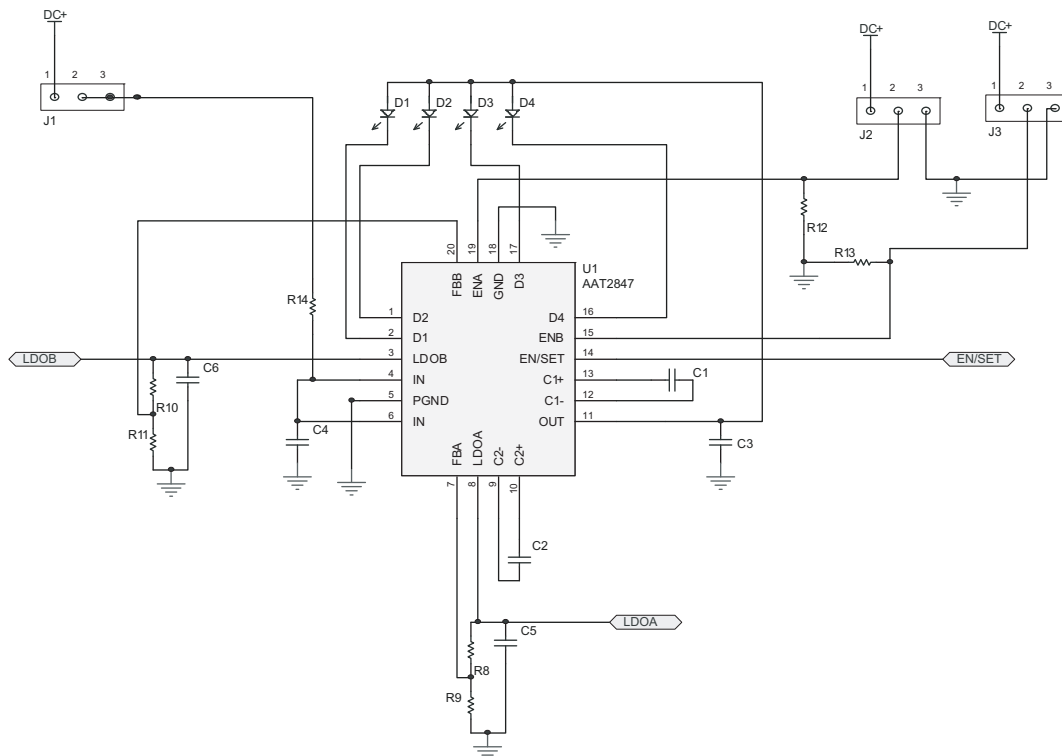

Figure 7: AAT2847 Section Schematic.

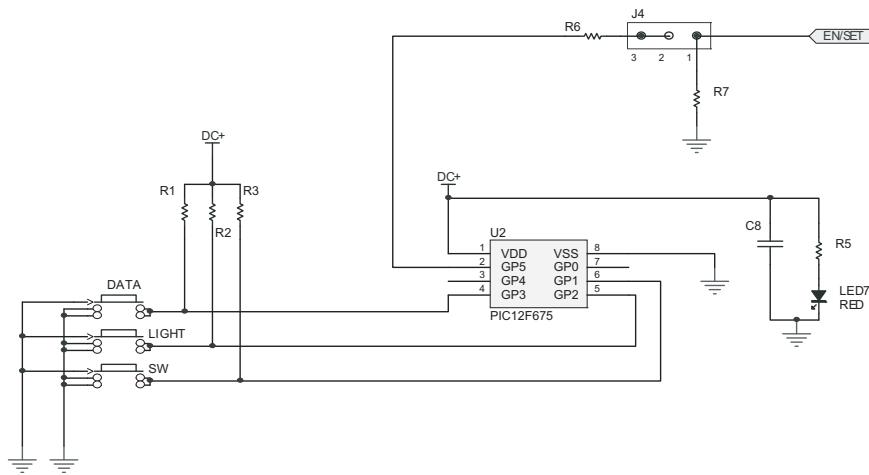

Figure 8: MCU Section Schematic.

Ordering Information

Package	Low Dropout Regulators		Marking ¹	Part Number (Tape and Reel) ²
	LDOA	LDOB		
TQFN34-20	Programmable	Programmable	YLXXY	AAT2847IML-EE-T1
TQFN34-20	2.8V	1.5V		AAT2847IML-QG-T1
TQFN34-20	2.8V	1.8V	ZDXY Y	AAT2847IML-QI-T1



All AnalogicTech products are offered in Pb-free packaging. The term “Pb-free” means semiconductor products that are in compliance with current RoHS standards, including the requirement that lead not exceed 0.1% by weight in homogeneous materials. For more information, please visit our website at <http://www.analogictech.com/pbfree>.

1. XYY = assembly and date code.

2. Sample stock is generally held on part numbers listed in **BOLD**.

Package Information¹

TQFN34-20

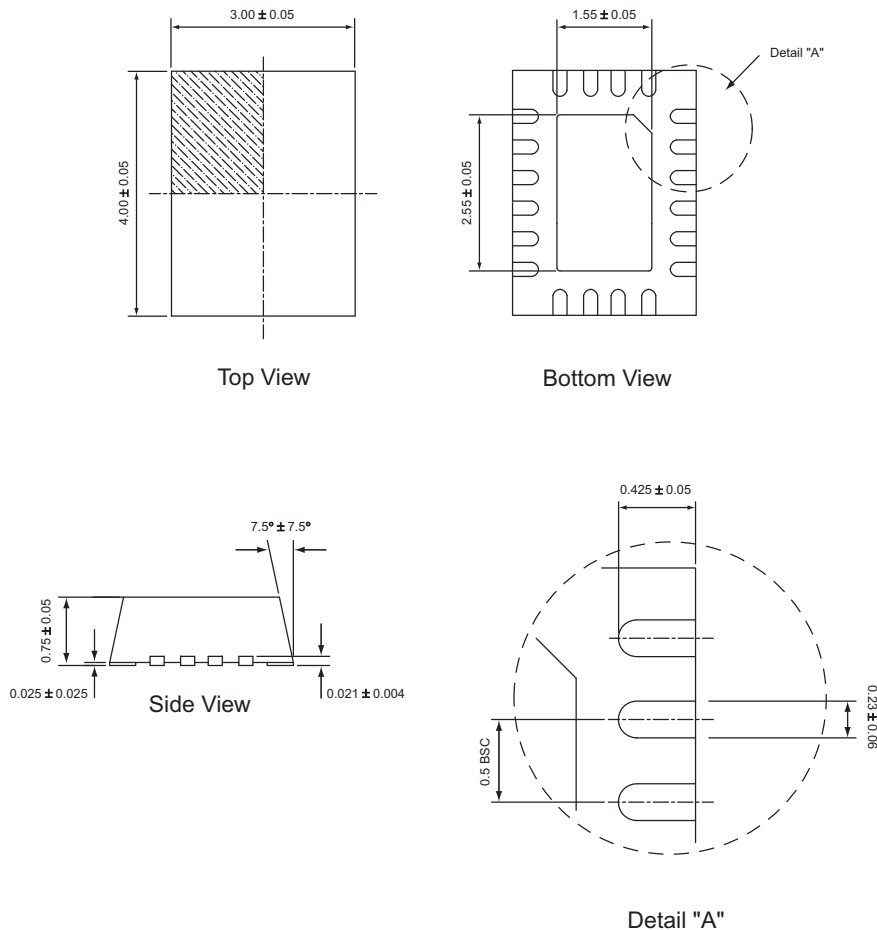

All dimensions in millimeters.

1. The leadless package family, which includes QFN, TQFN, DFN, TDFN, and STDFN, has exposed copper (unplated) at the end of the lead terminals due to the manufacturing process. A solder fillet at the exposed copper edge cannot be guaranteed and is not required to ensure a proper bottom solder connection.

© Advanced Analogic Technologies, Inc.

AnalogicTech cannot assume responsibility for use of any circuitry other than circuitry entirely embodied in an AnalogicTech product. No circuit patent licenses, copyrights, mask work rights, or other intellectual property rights are implied. AnalogicTech reserves the right to make changes to their products or specifications or to discontinue any product or service without notice. Except as provided in AnalogicTech's terms and conditions of sale, AnalogicTech assumes no liability whatsoever, and AnalogicTech disclaims any express or implied warranty relating to the sale and/or use of AnalogicTech products including liability or warranties relating to fitness for a particular purpose, merchantability, or infringement of any patent, copyright or other intellectual property right. In order to minimize risks associated with the customer's applications, adequate design and operating safeguards must be provided by the customer to minimize inherent or procedural hazards. Testing and other quality control techniques are utilized to the extent AnalogicTech deems necessary to support this warranty. Specific testing of all parameters of each device is not necessarily performed. AnalogicTech and the AnalogicTech logo are trademarks of Advanced Analogic Technologies Incorporated. All other brand and product names appearing in this document are registered trademarks or trademarks of their respective holders.

Advanced Analogic Technologies, Inc.
 3230 Scott Boulevard, Santa Clara, CA 95054
 Phone (408) 737-4600
 Fax (408) 737-4611